

## Temperature Controller TC10 Series

47 - 66 Hz)

### TEMPERATURE CONTROLLER

(Modbus use)

#### Functions & Features

- Two PID controllers\*
  - Universal input x 2 points, control output x 4 points, discrete input x 2 points, clamp-on current sensor input x 2 points
  - 2 universal inputs configurable to T/C, RTD, DC current or voltage independently
  - Discrete inputs usable to switch PID bank or operation mode
  - Control outputs configurable to MV, PV or alarm
  - Clamp-on current sensor input enables to detect heater wire break or over current
  - Auto tuning function
- \*Only single loop control is available while loop 1 remote SP is enabled.

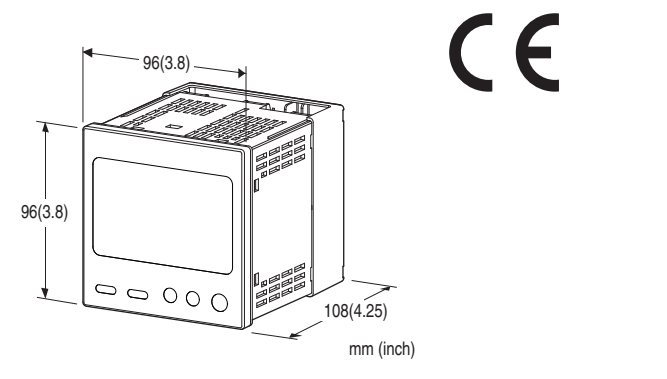

### MODEL: TC10EM-[1]-M2

#### ORDERING INFORMATION

- Code number: TC10EM-[1]-M2
- Specify a code from below for [1].  
(e.g. TC10EM-A-M2)

#### [1] CONTROL OUTPUT

- A:** 0 - 20 mA DC (Load resistance 500 Ω max.)  
Open-collector 2 points
- V:** 0 - 10 V DC (Load resistance 2 kΩ max.)  
Open-collector 2 points
- P:** 12 V pulse (Load resistance 600 Ω max.)  
Open-collector 2 points

#### POWER INPUT

##### AC Power

**M2:** 100 - 240 V AC (Operational voltage range 85 - 264 V,

#### RELATED PRODUCTS

- PC configurator software (model: TC10CFG)  
Downloadable at M-System's web site.  
A dedicated cable is required to connect the module to the PC. Please refer to the internet software download site or the users manual for the PC configurator for applicable cable types.
- Clamp-on current sensor (model: CLSE)  
(Used for detecting the heater wire break)

#### GENERAL SPECIFICATIONS

**Construction:** Panel flush mounting  
**Degree of protection:** IP65; applicable to the front panel of the unit with single mounting according to the specified panel cutout  
**Configuration jack:** 2.5 dia. miniature jack connector; RS-232-C level  
**Connection:** M3 separable screw terminal (torque 0.5 N·m)  
**Solderless terminal:** Refer to the drawing at the end of the section.

**Recommended manufacturer:** Japan Solderless Terminal MFG.Co.Ltd, Nichifu Co.,Ltd

**Applicable wire size:** 0.25 to 1.65 mm<sup>2</sup> (AWG 22 to 16)

**Screw terminal:** Nickel-plated steel

**Isolation:** Pv1 to Pv2 to CT1 or CT2 to Di1 or Di2 to MV1 or MV2 to Do1 or Do2 to Modbus to power

##### CT Input waveform

**RMS sensing:** Up to 15 % of 3rd harmonic content

**Control mode:** Standard PID, heating and cooling control (ON/OFF, PID)

**Proportional band (P):** 0.1 to 3200.0 (temperature unit)

**Integral time (I):** 0 to 3999 sec.

**Derivative time (D):** 0.0 to 999.9 sec.

**Auto-tuning:** Limit cycle method

**Alarm:** Deviation high & low, absolute high & low, etc.

**Sampling cycle:** 100 msec.

**Control cycle:** 1.0 to 99.9 sec.

(100 msec. fixed for MV output 0 - 20 mA DC and 0 - 10 V DC)

**MV output range:** -5 - +105 % for output scale

**Parameters:** Stored in non-volatile memory; write/erase cycle endurance: less than 1 000 000

**Parameter setting:** With front panel operation buttons or PC configurator software (model: TC10CFG)

- Universal input
- Burnout
- Control output
- Loop
- Bank

- Event input
- CT input
- Auto-tuning

Refer to the instruction manual for detail.

## ■ Recommended solderless terminal

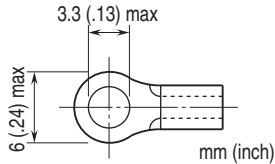

## MODBUS COMMUNICATION

**Communication:** Half-duplex, asynchronous, no procedure

**Standard:** Conforms to RS-485

**Transmission distance:** 500 meters max.

**Transmission media:** Shielded twisted-pair cable (CPEV-S 0.9 dia.)

**Node address:** 1 to 247

**Data mode:** RTU (Binary)

**Parity:** None, even or odd

**Baud rate:** 4800, 9600, 19.2 k, 38.4 k, 57.6 k (bps)

**Stop bit:** 1 or 2

**Node address, parity, baud rate setting:** With front panel operation buttons or PC configurator software (model: TC10CFG)

**Terminating resistor:** Built-in (Enable by shorting between pin 4 and 5)

## DISPLAY

**PV display:** 5 digits 7-segment green LED, 19.5 mm (.77") height

**SP display:** 5 digits 7-segment red LED, 12.5 mm (.49") height, switchable to MV display

**Display range:** -32000 to 32000

**Decimal point position:**  $10^{-1}$  to  $10^{-4}$  or none

**Zero indication:** Higher-digit zeros are suppressed. Loop status indicators

Loop1: Amber LED turns on when loop 1 chosen

Loop2: Amber LED turns on when loop 2 chosen

Bank1: Green LED turns on when bank 1 chosen

Bank2: Green LED turns on when bank 2 chosen

Bank3: Green LED turns on when bank 3 chosen

Bank4: Green LED turns on when bank 4 chosen

Alarm1: Red LED turns on at alarm 1

Alarm2: Red LED turns on at alarm 2

Alarm3: Red LED turns on at alarm 3

Alarm4: Red LED turns on while setting is saving to the non-volatile memory.

Run: Green LED turns on while loop is in operation.

Man: Green LED turns on during manual mode

Local: Green LED turns on when local SP chosen

At: Green LED turns on during auto-tuning

Out1: Green LED turns on when MV1 output

Out2: Green LED turns on when MV2 output

## INPUT SPECIFICATIONS

### ■ Universal input 1, 2 (Pv1, Pv2)

For type and range configuration, refer to the instruction manual.

**DC Current:**

**Input range:** 0 - 20 mA DC

**Input resistance:** 49.9  $\Omega$  resistor incorporated

- DC voltage input

**Input resistance:**  $\geq 10$  k $\Omega$  (-1000 to +1000 mV DC)

**Input resistance:**  $\geq 1$  M $\Omega$  (-10 to + 10 V DC)

- Thermocouple

**Input resistance:**  $\geq 10$  k $\Omega$

**Burnout sensing:**  $\leq 4$   $\mu$ A

- RTD (2-wire or 3-wire)

**Excitation:**  $\leq 0.33$  mA

**Allowable leadwire resistance:** 20  $\Omega$  per wire

- Resistance

**Excitation:**  $\leq 0.33$  mA

**Allowable leadwire resistance:** 20  $\Omega$  per wire

- Potentiometer

**Excitation:**  $\leq 0.33$  mA

**Input range:** 0 to 4000  $\Omega$

**Allowable leadwire resistance:** 20  $\Omega$  per wire

### ■ Clamp-on current sensor (CT1, CT2)

(Sensor model No.: AC input)

CLSE-R5: 0 - 5 A

CLSE-05: 0 - 50 A

CLSE-10: 0 - 100 A

CLSE-20: 0 - 200 A

CLSE-40: 0 - 400 A

CLSE-60: 0 - 600 A

**Frequency:** 50 / 60 Hz

**Operational range:** 0 - 120 % of rating

**Overload capacity:**

CLSE-R5: 10 A continuous

CLSE-05: 60 A continuous

CLSE-10: 120 A continuous

CLSE-20: 240 A continuous

CLSE-40: 480 A continuous

CLSE-60: 720 A continuous

Be sure that the input voltage is of 480 V or less.

### ■ Discrete Input (Di1, Di2)

**Contact rating:** 3.3 V @1 mA

**Detection levels:**

$\leq 15$  k $\Omega$  / 0.5 V at close

$\geq 350$  k $\Omega$  / 2.5 V at open

## OUTPUT SPECIFICATIONS

Four control outputs are configurable to Mv, Ao or Do.

### ■ Control Output (Mv1, Mv2)

Specify the type of output with the code number.

■ DC Current: 0 – 20 mA DC

Operational range: 0 – 23 mA DC

Load resistance:  $\leq 500 \Omega$

■ DC Voltage: 0 – 10 V DC

Operational range: 0 - +11.5 V DC

Load resistance:  $\geq 2 \text{ k}\Omega$

### ■ Voltage Pulse

Maximum frequency: 1 Hz

Minimum pulse width: 1 msec.

Hi level: 12 V  $\pm 15 \%$

Lo level:  $\leq 0.5 \text{ V}$

Load resistance: 600  $\Omega$  min.

### ■ Control Output (Do1, Do2)

• Open collector

Maximum frequency: 1 Hz

Minimum pulse width: 1 msec.

Output rating: 50 V DC 100 mA (resistive load)

Saturation voltage: 0.5 V DC

Burnout response (thermocouple, RTD input):  $\leq 10 \text{ s}$

Insulation resistance:  $\geq 100 \text{ M}\Omega$  with 500 V DC

Dielectric strength: 2000 V AC @1 minute (Pv1 to Pv2 to CT1 or CT2 to Di1 or Di2 to MV1 or MV2 to Do1 or Do2 to Modbus to power to ground)

## STANDARDS & APPROVALS

### EU conformity:

EMC Directive

EMI EN 61000-6-4

EMS EN 61000-6-2

Low Voltage Directive

EN 61010-1

Installation Category II

Pollution Degree 2

Input to output to power – Reinforced insulation (300 V)

Input or output or power to Modbus – Basic insulation (300 V)

RoHS Directive

EN 50581

## INSTALLATION

### Power Consumption

•AC:

Approx. 6 VA at 100 V

Approx. 7 VA at 200 V

Approx. 8 VA at 240 V

Operating temperature: -10 to +55°C (14 to 131°F)

Operating humidity: 5 to 90 %RH (non-condensing)

Atmosphere: No corrosive gas or heavy dust

Mounting: Panel flush mounting

Weight: 450 g (0.99 lb)

## PERFORMANCE in percentage of span

### Accuracy

• Pv1 or Pv2: Refer to "Input type, range & conversion accuracy" section.

• CT1 or CT2:  $\pm 2 \%$  (sensor error margin not included)

• MV1 or MV2:  $\pm 0.5 \%$

Cold junction compensation error (thermocouple input):

$\pm 2.0^\circ\text{C}$  at 0 – 50°C ( $\pm 3.6^\circ\text{F}$  at 32 – 122°F)

CJC sensor is adjacently attached to the input terminals.

CJC is available for each universal input 1 and 2.

### Temp. coefficient

• Pv1 or Pv2:  $\pm 0.03 \%/^\circ\text{C}$  ( $\pm 0.02 \%/^\circ\text{F}$ )

• CT1 or CT2:  $\pm 0.03 \%/^\circ\text{C}$  ( $\pm 0.02 \%/^\circ\text{F}$ )

### Response time

• CT1 or CT2:  $\leq 2 \text{ sec.}$  (0 – 90 %)

• Mv1 or Mv2:  $\leq 1 \text{ sec.}$  (0 – 90 %, DC output)

## INPUT TYPE, RANGE & CONVERSION ACCURACY

INPUT TYPE		INPUT RANGE		ACCURACY		
DC CURRENT		0 to 20mA DC		±20µA		
DC VOLTAGE		-1000 to +1000mV DC		When max. range*2 is ≥60mV ±20µV When max. range*2 is ≤120mV ±30µV When max. range*2 is ≥120mV ±200µV		
POTENTIOMETER		-10 to +10V DC		±10mV ±0.1%		
RESISTOR		Total resistance up to 4000Ω*3		±0.1Ω or ±0.1%, whichever is greater		
		0 to 4000Ω		±0.1Ω or ±0.1%, whichever is greater		
Thermocouple	°C			°F		
	INPUT RANGE	ACCURACY *1	CONFORMANCE RANGE	INPUT RANGE	ACCURACY *1	CONFORMANCE RANGE
(PR)	0 to 1760	±1.80	0 to 1760	32 to 3200	±3.24	32 to 3200
K (CA)	-270 to +1370	±0.40	-150 to +1370	-454 to +2498	±0.72	-238 to +2498
E (CRC)	-270 to +1000	±0.60	-170 to +1000	-454 to +1832	±1.08	-274 to +1832
J (IC)	-210 to +1200	±0.70	-180 to +1200	-346 to +2192	±1.26	-292 to +2192
T (CC)	-270 to +400	±0.50	-170 to +400	-454 to +752	±0.90	-274 to +752
B (RH)	100 to 1820	±2.00	400 to 1760	212 to 3308	±3.60	752 to 3200
R	-50 to +1760	±1.00	200 to 1760	-58 to +3200	±1.80	392 to 3200
S	-50 to +1760	±1.00	0 to 1760	-58 to +3200	±1.80	32 to 3200
C (WRe 5-26)	0 to 2315	±1.00	0 to 2315	32 to 4199	±1.80	32 to 4199
N	-270 to +1300	±0.50	-130 to +1300	-454 to +2372	±0.90	-202 to +2372
U	-200 to +600	±0.50	-200 to +600	-328 to +1112	±0.90	-328 to +1112
L	-200 to +900	±0.30	-200 to +900	-328 to +1652	±0.54	-328 to +1652
P (Platinel II)	0 to 1395	±0.30	0 to 1395	32 to 2543	±0.54	32 to 2543
RTD	°C			°F		
	INPUT RANGE	ACCURACY		INPUT RANGE	ACCURACY	
Pt 100 (JIS '97, IEC)	-200 to +850	±0.40		-328 to +1562	±0.72	
Pt 500	-200 to +850	±0.40		-328 to +1562	±0.72	
Pt 1000	-200 to +850	±0.40		-328 to +1562	±0.72	
Pt 50Ω (JIS'81)	-200 to +649	±0.60		-328 to +1200	±1.08	
JPt 100 (JIS'89)	-200 to +510	±0.40		-328 to +950	±0.72	
Ni 508.4Ω	-50 to +200	±0.60		-58 to +392	±1.08	
Cu 10 (25°C)	-50 to +250	±2.00		-58 to +482	±3.60	

\*1. Thermocouple: Add 2.0°C of cold-junction-compensation error.

\*2. Max. range: absolute range (greater of 0% and 100% range values), whichever is greater.

\*3. Refer to the operating manual for details.

## EXTERNAL VIEW

### FRONT VIEW

### REAR VIEW

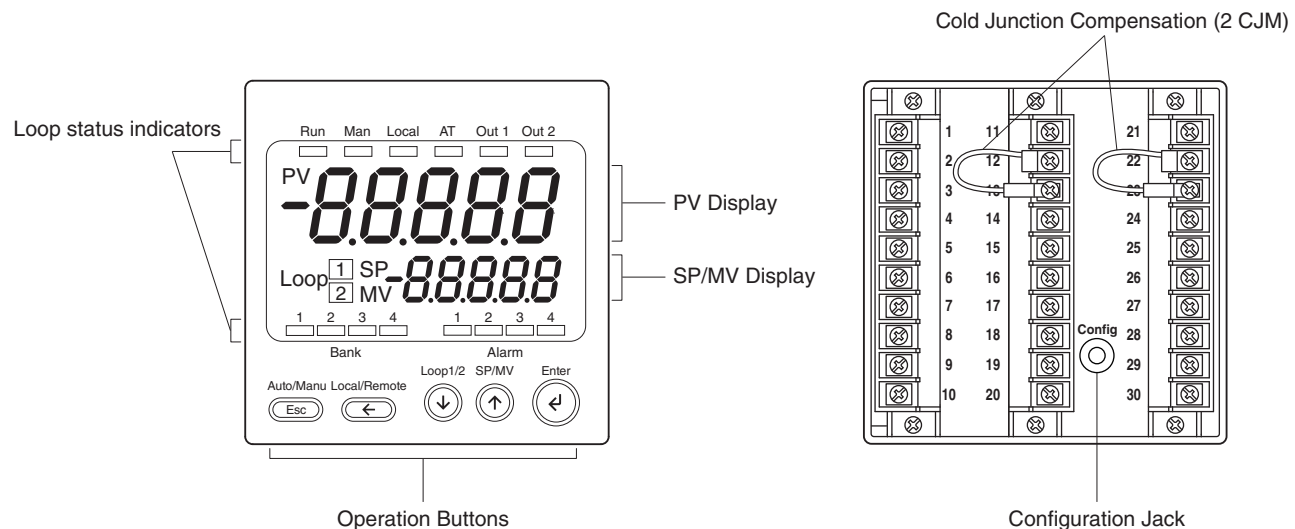

## CONNECTION DIAGRAMS

### ■ MASTER CONNECTION

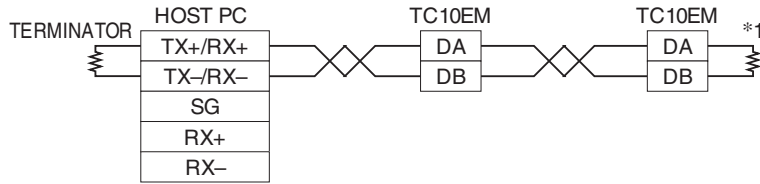

NO.	ID	FUNCTION
6	DA	DA
7	DB	DB

\*1. For using internal terminator, short-across terminals 4 and 5.

## DIMENSIONS unit: mm (inch)

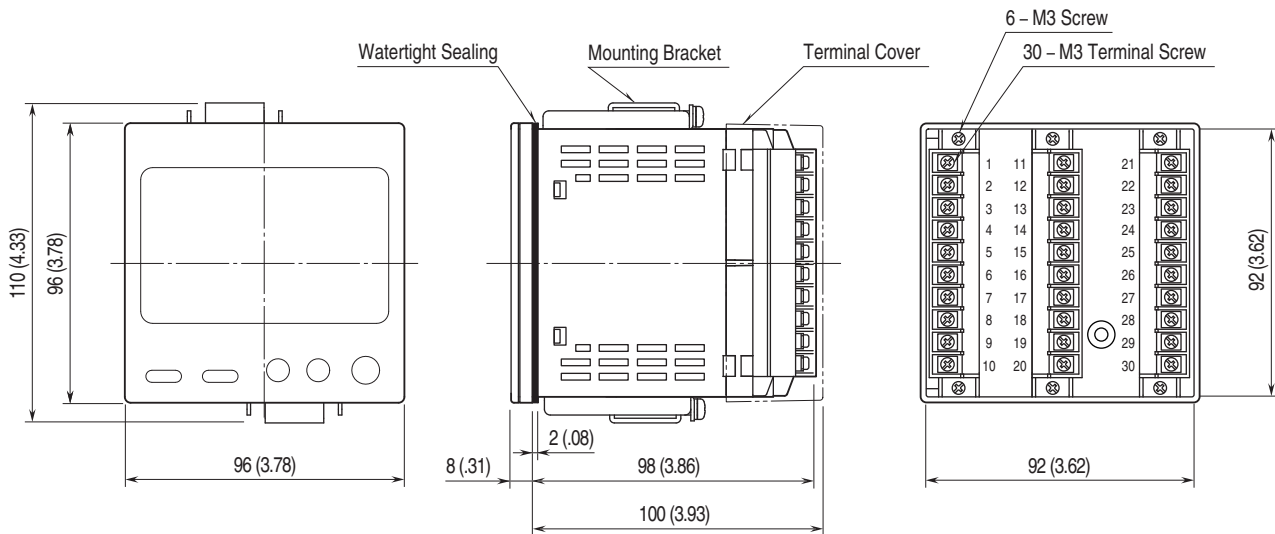

### ■ PANEL CUTOUT unit: mm (inch)

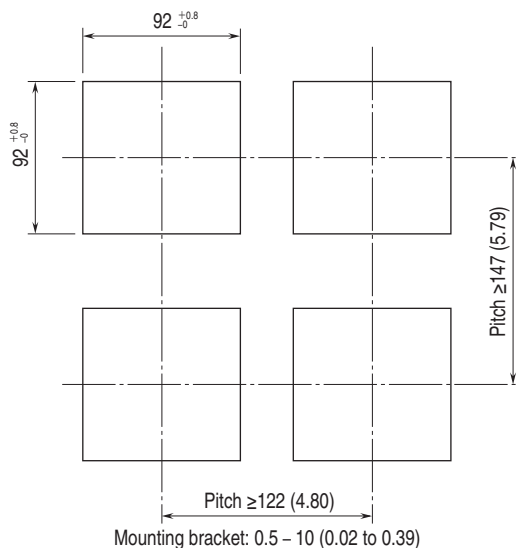

## SCHEMATIC CIRCUITRY & CONNECTION DIAGRAM

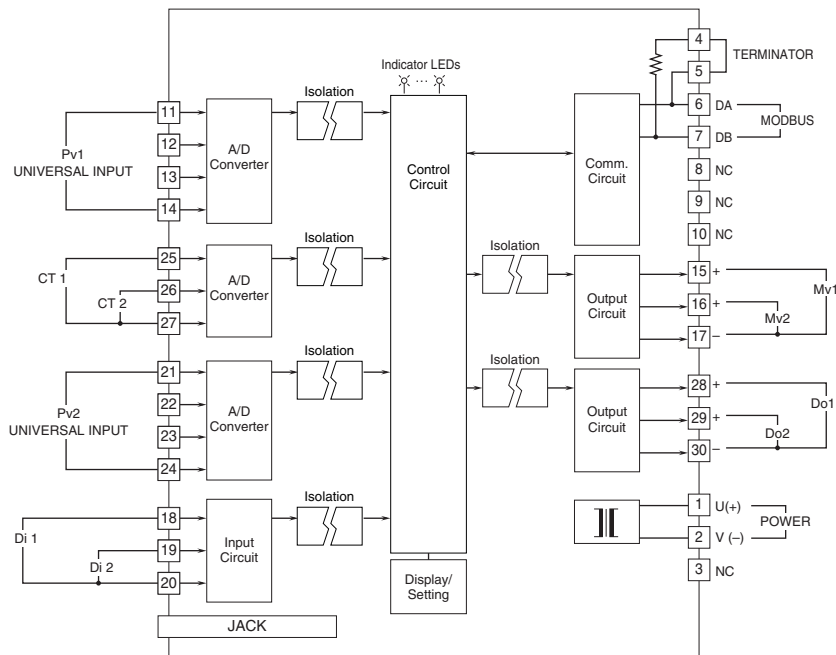

### ■ UNIVERSAL INPUT CONNECTION (Pv1) e.g.

- DC Voltage (-10 ~ +10V DC)
- DC Current (0 ~ 20mA DC)

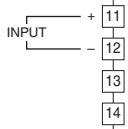

- DC Voltage (-1000 ~ +1000mV DC)

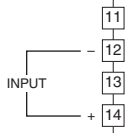

### •Thermocouple

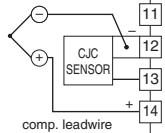

### •RTD/Resistor (3-wire)

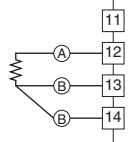

### •RTD/Resistor (2-wire)

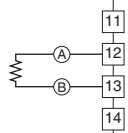

### •Potentiometer

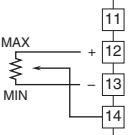

### ■ UNIVERSAL INPUT CONNECTION (Pv2) e.g.

- DC Voltage (-10 ~ +10V DC)
- DC Current (0 ~ 20mA DC)

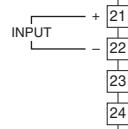

- DC Voltage (-1000 ~ +1000mV DC)

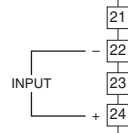

### •Thermocouple

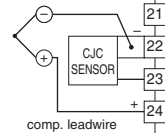

### •RTD/Resistor (3-wire)

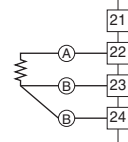

### •RTD/Resistor (2-wire)

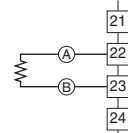

### •Potentiometer

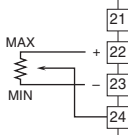

### ■ CT 1 / CT 2 CONNECTION e.g.

- Clamp-on current Sensor

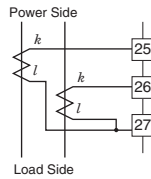

### ■ DISCRETE INPUT CONNECTION e.g.

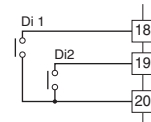

### ■ CONTROL OUTPUT 1 & 2 CONNECTION e.g.

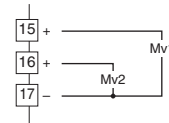

### ■ CONTROL OUTPUT 3 & 4 CONNECTION e.g.

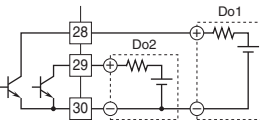



Specifications are subject to change without notice.