

ABB MEASUREMENT & ANALYTICS | DATA SHEET

AWT420

Universal 4-wire, dual-input transmitter



Measurement made easy

The most versatile general process transmitter for water analysis

Universal modular design

- mix-and-match a wide range of analog and advanced digital EZLink™ sensors
- factory calibrated sensor and communication modules minimize stock holding and maximize operation uptime
- wall-, panel- or pipe-mountable

Easy to use

- intuitive software with full-color graphical display
- plug-and-play digital sensor connection using EZLink technology
- 'Easy Setup' menus provide step-by-step guidance

High functionality at minimum cost

- dual channel PID control
- full audit trail capability for improved regulatory compliance
- secure data archiving to SD card

Integrated Bluetooth® for direct connection to your smart device

- view device data in real time or analyze later in offline mode
- access the latest software updates and essential sensor information
- keep track of maintenance tasks and view maintenance logs at a glance

Flexible communications

- HART, Ethernet, PROFIBUS DP or MODBUS digital communications
- advanced self-diagnostics conforming to NAMUR NE 107 provide harmonized indication of device status

The AWT420 dual-input transmitter

The AWT420 dual-channel transmitter provides true flexibility for measuring a wide variety of parameters in a single device. Packed with a host of features including Bluetooth connectivity, dual PID control and EZ-Link sensor connection, water analysis has never been easier.

Operation simplicity is a key feature of the AWT420 with its powerful, yet intuitive software, advanced self-diagnostics and its unique modular design that enables users to achieve increased efficiency through greater user flexibility, reduced process downtime and simplified maintenance.

The robust IP66 enclosure can be easily wall-, pipe- or panel-mounted. The hinged door with anti-tamper indication provides unrestricted access to the communication and sensor modules for simplified commissioning and maintenance.

The AWT420 transmitter can be used with either analog or digital EZLink sensors for a wide range of applications including drinking water, wastewater, industrial water and power.

Versatile modular design

The unique modular design of the AWT420 enables the same unit to be used with any of the available or future sensor and communication modules, minimizing stock holding and maximizing operational uptime.

Each module is factory-calibrated and can be quickly and securely installed by hand in seconds, providing the ultimate in transmitter adaptability.

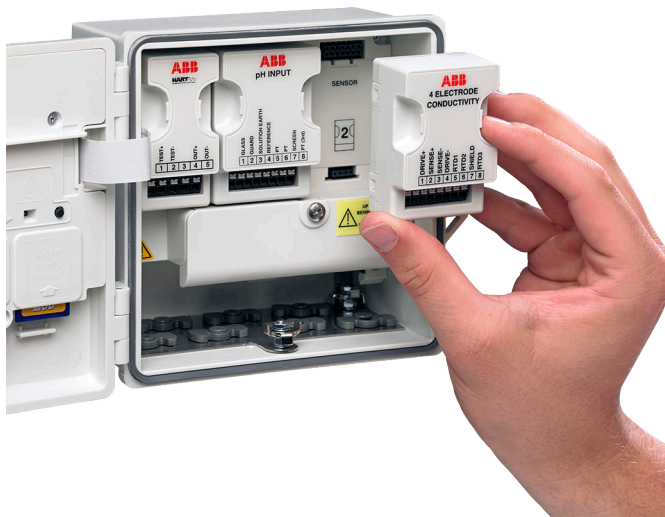

Sensor compatibility

pH and redox (ORP) measurement

The AWT420 pH/ORP module is compatible with ABB's full range of analog pH, redox (ORP) sensors in addition to most competitors' sensors.

For measuring process liquids that change pH value based on temperature, a pH solution coefficient can be entered that compensates the Nernstian value for pH measurements, and the raw voltage value for ORP measurements, by a fixed value per each 10 °C (18 °F).

Conductivity measurement

The AWT420 fully supports ABB's range of 2-electrode and 4-electrode sensors for conductivity, resistivity, concentration and inferred pH measurement making the AWT420 suitable for installations ranging from ultra-pure water to harsh chemical applications.

For users that use conductivity to infer liquid concentration a concentration curve can be entered using the 6-point linearizer table.

EZLink digital sensors

The AWT420 EZLink module is compatible with ABB's range of EZLink digital sensors providing plug-and-play sensor connectivity, automatic sensor recognition/set-up and advanced predictive diagnostics.

Compatible EZLink digital sensors:

Parameter	Sensor
pH/ORP	100 GP-D, 100 ULTRA-D, 500 PRO-D, 700 ULTRA-D
Turbidity/Suspended solids	ATS430
Dissolved oxygen	ADS430

Flexible communications

The AWT420 transmitter is available with a wide choice of user-selectable communication modules including HART, Ethernet, PROFIBUS DP V1.0 or Modbus RS485; enabling simple device integration.

The Ethernet module contains an embedded webserver that enables the unit to be viewed remotely and fully controlled securely via a web browser. Configuration data and process data can be downloaded via secure FTP connection.

Communication modules can be configured when purchased or easily retrofitted in the field.

Direct connection to your smart device

Connect to any iOS or Android device via Bluetooth using the EZLink connect app to access essential sensor information wherever and whenever you need it to ensure your process is continually operating at maximum efficiency.

From checking your audit logs to downloading the latest software through your smartphone, we are confident that EZLink connect will make your life that little bit easier by providing you with a wealth of information and services to support you wherever and whenever you need it.

- Easily and securely connect to your device to view all measurement, diagnostic and audit data in real time or analyze later in offline mode
- Access the latest software updates and essential sensor information direct through your smartphone
- Keep track of all current and upcoming maintenance tasks and view completed maintenance logs at a glance



Easy to use

ABB's intuitive HMI is both powerful, yet user-friendly with simple navigation and clear menus presented on the large easy-to-read full-color graphical display. Easy Setup sensor configuration menus provide step-by-step guidance for commissioning new sensors and the advanced self-diagnostics conforming to NAMUR NE 107 provide harmonized indication of device status.

Graphical trending

Measurement trends of each sensor can be viewed locally easily and clearly on the graphical color display.

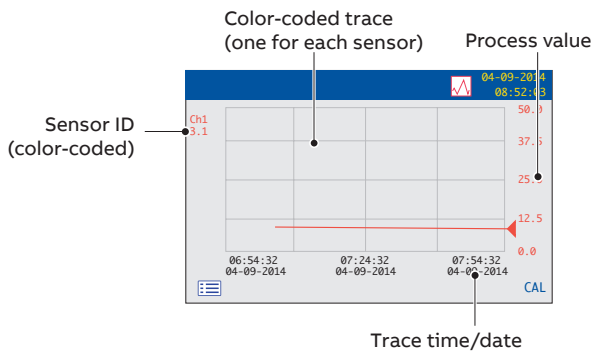

Full audit trail capability

The AWT420 transmitter records all data to its internal memory continuously. This includes both event log/ configuration data in addition to measurement data. The transmitter's event log files contain audit log, alarm log, diagnostic log and calibration log data that is time- and date-stamped, providing the operator with full audit trail capability.

04-09-2014 10:03:25			
01	Power Failure	03:09:14	22:03:24
02	Power Recovery	23:06:14	14:17:03
03	Power Failure	15:05:14	02:21:54
04	Power Recovery	08:04:14	11:08:31
CAL			

Secure data archiving to SD card

Process data and historical logs can be securely archived to an SD card for record keeping or analysis using ABB's DataManager Pro data analysis software.

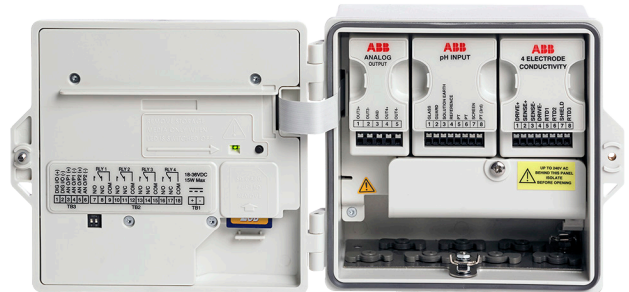

Simplified calibration

With the AWT420 One-Button Calibration feature, sensor calibration can be initiated directly without the need to access the device menu, reducing overall time spent calibrating sensors.

Secure process control

Multi-level security access prevents unauthorized modification of process control data by enabling separate read-only, calibrate and advanced security access levels to users.

Advanced process control functionality as standard

Dual channel PID control

The AWT420 transmitter incorporates three-term PID control, offering three modes of sophisticated control:

- analog
- pulse length (time proportional)
- pulse frequency.

Control functionality is available for both channels of the AWT420 transmitter and are configurable for reverse or direct-acting control. pH channels are configurable for reverse-acting, direct-acting or dual (acid/base) control.

Cation conductivity and inferred pH measurement

In low conductivity, ammoniated boiler waters, the AWT420 transmitter can calculate an inferred pH measurement from the conductivity and a pre-set ammonia concentration.

For inferred pH measurement calculations, the AWT420 uses the inputs from two conductivity sensors, i.e. before and after cation exchange column. The AWT420 software contains a number of inferred pH calculations to allow for different chemical conditions, i.e. whether or not the system is an NH₃, NH₃+NaCl or NaOH dosed system.

Self-monitoring of the validity of the pH measurement is achieved by checking that an after-cation conductivity value is sufficiently low. This measurement is provided by the second input of the AWT420 transmitter. Alarm contacts can be configured for cation conductivity, invalid pH and exhausted resin.

Advanced dual-conductivity calculations

In addition to inferred pH measurement, the AWT420 provides advanced dual-conductivity calculations used across a range of industrial processes including demineralization and reverse osmosis control.

The AWT420 is able to calculate, display and transmit the difference, ratio, % passage or % rejection between two conductivity sensors.

Automated sensor cleaning

The AWT420 transmitter can automate sensor cleaning regimes to reduce operational expenditure and ensure effective sensor measurement. Pulsed or continuous cleaning routines can be assigned to any of the relays or digital output. The frequency and duration of the cleaning can be tuned to meet the specific requirements of the application.

Dimensions

Dimensions in mm (in)

Transmitter

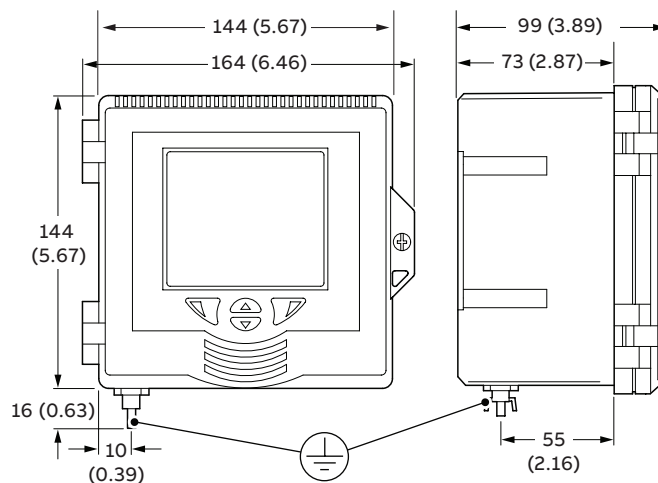

Optional weather shield

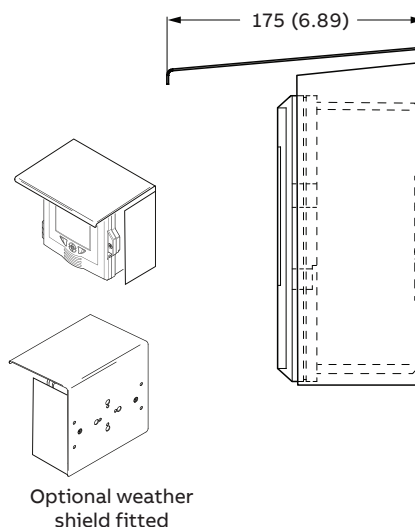
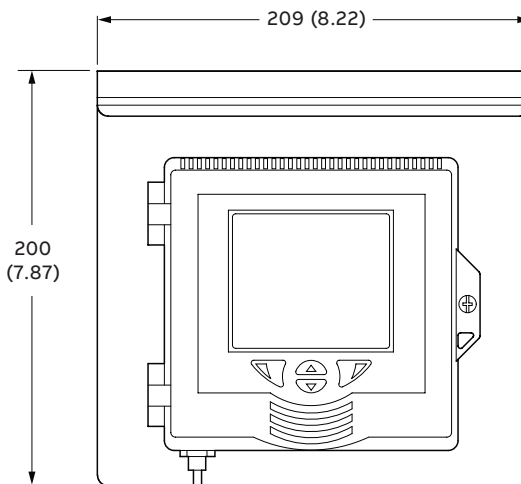

Mounting options

Wall-mounting

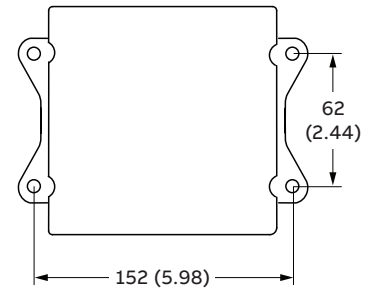
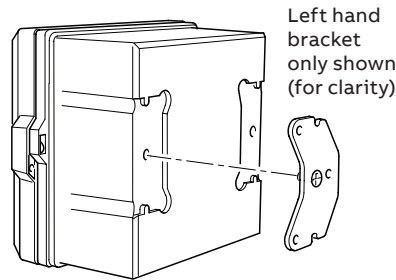
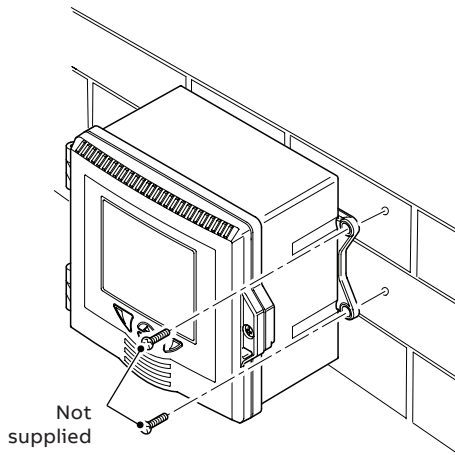

Panel-mounting

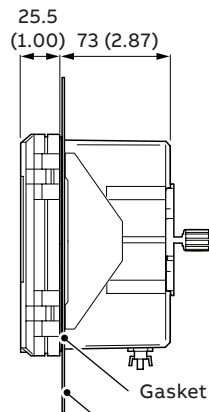
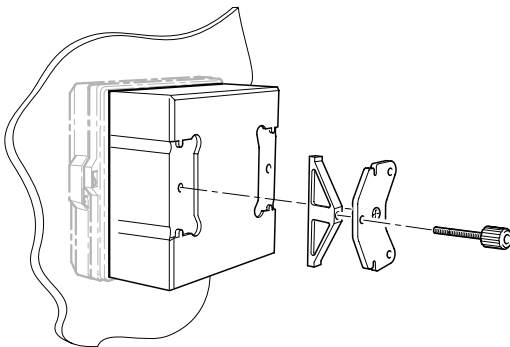

Panel cut-out dimensions

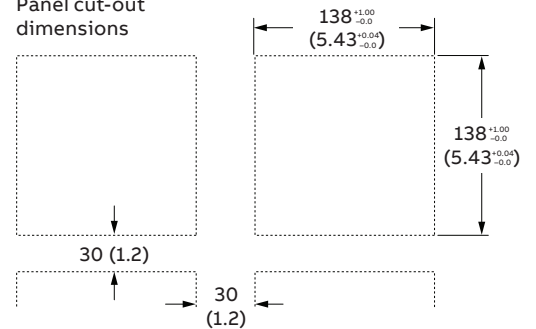

Pipe-mounting

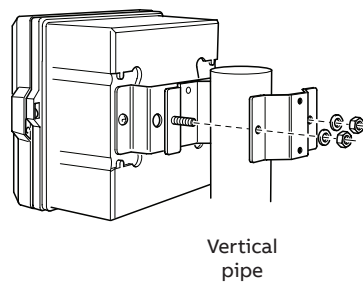
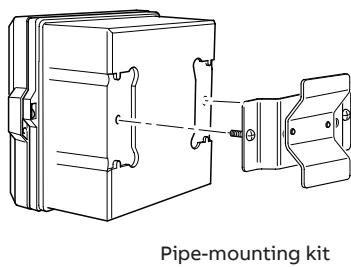

Pipe diameters: max. 62 (2.44)/min. 45 (1.77)

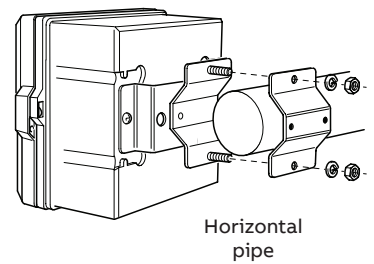

Specification

Operation

Display

89 mm (3.5 in) color ¼ VGA TFT, liquid crystal display (LCD) with built-in backlight and brightness/contrast adjustment

Language

English, German, French, Italian, Spanish

Keypad

6 tactile membrane keys:

- Group select/Left cursor
- View select/Right cursor
- Menu key
- Up
- Down
- Enter key

No. of inputs

Up to 2 analog or digital sensors

Mechanical data

Protection

IP66/NEMA 4X

Dimensions

- Height: 144 mm (5.67 in) minimum (excluding glands)
- Width: 144 mm (5.67 in) door closed – min.
- Depth: 99 mm (3.89 in) door closed – min. (excluding fixing brackets)
- Weight: aluminium enclosure
1.36 kg (3 lb) approx. (unpacked)
- Weight: polycarbonate enclosure
1 kg (2.2 lb) approx. (unpacked)

Panel dimensions

- Cut-out height: 138 +1 –0 mm (5.43 +0.04 –0 in)
- Cut-out width: 138 +1 –0 mm (5.43 +0.04 –0 in)
- Thickness: 6.35 mm (0.25 in) max.
- Depth behind panel: 100 mm (4 in) min. (after fixing with brackets to panel)
- Distance between cut-outs: 40 mm (1.57 in) min.

Materials of construction

- Aluminium enclosure – LM20 aluminium
- Polycarbonate enclosure – LEXAN 505RU
10 % glass-filled polycarbonate

Cable entries

- Five holes to accept M20 or ½ in cable glands or conduit hubs
- Two holes to accept M16 cable glands or conduit hubs or EZLink connectors

Security

Password protection

Access to configuration levels is enabled only after the user has entered a password:

- Calibrate level: user-assigned password
- Advanced level: user-assigned password
- Service level: service level user-assigned password

Electrical

Supply voltage

100 to 240 V AC ±10 %, 50/60 Hz
24 V DC (18 min. to 36 V DC max.)

Power consumption

<15W

Terminal connections rating

Solid/Flexible wire: AWG 24 to 16 (0.2 to 1.5 mm²)
Ferrule with plastic sleeve 0.2 to 0.75 mm²
Ferrule without plastic sleeve 0.2 to 1.5 mm²

Cable specification

Cable glands:

- M20: 5 to 9 mm (0.2 to 0.35 in)
- M16: 2 to 6 mm (0.08 to 0.24 in)
- ½ in NPT: 6 to 12 mm (0.24 to 0.47 in)
- Ethernet: 4.7 to 6.35 mm (0.187 to 0.25 in)

Analog outputs

Number

- Two supplied as standard
- Four with module board fitted

Output ranges

Analog output programmable to any value between 0 and 22 mA to indicate system failure

Accuracy

±0.25 % of reading or 10 µA (whichever is the greater)

Maximum load resistance

500Ω at 20 mA

Configuration

Can be assigned to either measured variable or either sample temperature

Isolation

500 V DC from any other circuitry but not from each other

Relay outputs

- 4 standard single-pole changeover
- Fully-programmable
 - Contacts rating: 5A @ 110/240 V AC (Non-Inductive) 5A @ 30 V DC

Digital input/output

- 1 standard, user-programmable as input or output
- Minimum input pulse duration: 125 ms
- Input – volt-free
- Output – open-collector, 12 to 24 V, 250 mA max.

Connectivity/Communications (optional)

Ethernet

HTTP, HTTPS, FTP, Secure FTP

PROFIBUS DP

DPV0, DPV1

MODBUS

RTU RS485

HART

- Fieldcomm certified version – HART 7
- Configured range
 - 4 to 20 mA, user-programmable across measurement range
- Dynamic range
 - 3.8 to 20.5 mA with 3.6 mA low alarm level, 21 mA high alarm level
- Accuracy
 - ± 0.25 % of reading
- Maximum load resistance
 - 500 Ω at 20 mA
- Configuration
 - Can be assigned to either measured variable
- Isolation
 - 500 V DC from any other circuitry

Data logging

Storage

- Measurement value storage (programmable sample rate)
- Audit log*, Alarm log*, Calibration log, Diagnostics log

Storage media

SD card, up to 32 GB capacity

Chart view

On local display

Historical review

Of data

Data transfer

SD card interface – Windows-compatible FAT file system, data and log files in Excel and DataManager Pro compatible formats

Environmental data

Ambient operating temperature:

–10 to 55 °C (14 to 131 °F)

Ambient operating humidity:

Up to 95 % RH non-condensing

Storage temperature:

–20 to 70 °C (–4 to 158 °F)

Altitude:

2000 m (6562 ft) max. above sea level

2-electrode conductivity

Conductivity input

Measurement range and resolution

Cell constant	Conductivity range	Display resolution	Accuracy repeatability
0.01	0 to 200 $\mu\text{S}/\text{cm}$	0.001 $\mu\text{S}/\text{cm}$	± 1.0 % of measurement range per decade
0.05	0 to 1000 $\mu\text{S}/\text{cm}$	0.001 $\mu\text{S}/\text{cm}$	
0.1	0 to 2000 $\mu\text{S}/\text{cm}$	0.01 $\mu\text{S}/\text{cm}$	
1	0 to 20000 $\mu\text{S}/\text{cm}$	0.1 $\mu\text{S}/\text{cm}$	

Dynamic response

<3 s for 90 % step change when damping is off

Damping

Configurable: off, low, medium and high

Temperature input

Temperature element types

- Automatic temperature sensor recognition for Pt100, Pt1000 and 3k Balco RTDs in either 2-lead or 3-lead configurations
- Temperature element can be used for automatic temperature compensation of the conductivity solution

Measurement range and resolution

Sensor group	Temperature range	Display resolution	Accuracy repeatability
Pt100	–20 to 200 °C	0.1 °C (0.1 °F)	0.1 °C (0.18 °F)
Pt1000	(–4 to 392 °F)		
3K Balco			
None	User-programmable –20 to 300 °C (–4 to 572 °F)		N/A

Temperature compensation modes

Linear, UPW, NaCl, HCl and NH₃

Reference temperature

25 °C (77 °F)

Configured output range

Cell constant	Min. span	Max. span
0.01	1 $\mu\text{S}/\text{cm}$	200 $\mu\text{S}/\text{cm}$
0.05	5 $\mu\text{S}/\text{cm}$	1000 $\mu\text{S}/\text{cm}$
0.1	10 $\mu\text{S}/\text{cm}$	2000 $\mu\text{S}/\text{cm}$
1	100 $\mu\text{S}/\text{cm}$	20000 $\mu\text{S}/\text{cm}$

* Audit log and Alarm log data are stored in the same log file.

...Specification

4-electrode conductivity

Conductivity input

Measurement range and resolution

Sensor group	Conductivity range	Display resolution	Accuracy repeatability
A	0 to 2000 mS/cm	0.1 μ S/cm	\pm 0.5 % of measurement range per decade
B	0 to 2000 μ S/cm	0.01 μ S/cm	

Dynamic response

<3 s for 90 % step change when damping is off

Damping

Configurable: off, low, medium and high

Temperature input

Temperature element types

- Automatic temperature sensor recognition for Pt100, Pt1000 and 3k Balco RTDs in either 2-lead or 3-lead configurations
- Temperature element can be used for automatic temperature compensation of the conductivity solution

Measurement range and resolution

Sensor group	Temperature range	Display resolution	Accuracy repeatability
Pt100	-20 to 200 °C		0.1 °C
Pt1000	(-4 to 392 °F)		(0.18 °F)
3K Balco		0.1 °C	
None	User-programmable -20 to 300 °C (-4 to 572 °F)	(0.1 °F)	N/A

Temperature compensation modes

- 0 to 15 % NaOH
- 0 to 18 % HCl
- 0 to 20 % H₂SO₄
- 0 to 40 % H₃PO₄
- 0 to 20 % NaCl
- 0 to 50 % KOH
- User-defined table

Reference temperature

25 °C (77 °F)

Configured output range

Sensor group	Min. span	Max. span
A	100 μ S/cm	2000 mS/cm
B	10 μ S/cm	2000 μ S/cm

pH/ORP (Redox) input

Sensor types

pH: Glass, Antimony (Sb)

ORP (Redox): Platinum (Pt), Gold (Au)

Input impedance

>1 \times 10¹³ Ω

Measurement range and resolution

Type	Range	Display resolution	Accuracy repeatability
pH	0 to 14 pH	0.01 pH	\pm 0.01 pH
ORP	\pm 2000 mV	1 mV	\pm 1800 MV: \pm 1 mV \pm 2000 MV: \pm 3 mV

Dynamic response

<3 s for 90 % step change when damping is off

Damping

Configurable: off, low, medium and high

pH/ORP (Redox) temperature input

Temperature element types

- Automatic temperature sensor recognition for Pt100, Pt1000 and 3k Balco RTDs in either 2-lead or 3-lead configurations
- Temperature element can be used for automatic temperature compensation of the conductivity solution

Measurement range and resolution

Sensor group	Temperature range	Display resolution	Accuracy repeatability
Pt100	-20 to 200 °C		0.1 °C
Pt1000	(-4 to 392 °F)		(0.18 °F)
3K Balco		0.1 °C	
None	User-programmable -20 to 300 °C (-4 to 572 °F)	(0.1 °F)	N/A

Temperature compensation modes

- pH: Manual, Automatic Nernstian, Nernstian with solution coefficient
- ORP: Manual, solution compensation coefficient

Reference temperature

25 °C (77 °F)

pH/ORP (Redox) configured output range

Type	Min. span	Max. span
pH	1 pH	14 pH
ORP	100 mV	4000 mV

EZLink

Power consumption (maximum)

150 mA @ 24 V DC (3.75 W max)

Fixed length cable

1 or 10 m (3.28 or 32.8 ft)

Digital sensor connector IP rating

IP67 (when connected)

Extension cable (options)

1, 5, 10, 15, 25, 50 m (3.2, 16.4, 32, 49.2, 82, 164 ft)

Maximum length (including optional extension cable)

Up to 210 m (826 ft)

EMC

Emissions & immunity

Meets requirements of IEC61326 for an industrial environment

Approvals, certification and safety

Safety approval

cULus

CE mark

Covers EMC & LV Directives (including latest version IEC 61010)

General safety

- IEC 61010-1
- Pollution degree 2
- Insulation class 1

Bluetooth

The Bluetooth Low Energy Module within the AWT420 transmitter has received the regulatory approval for the following countries:

- Europe/CE



- Japan/MIC: 005-101150

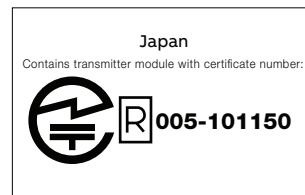

- Korea/KCC: MSIP-CRM-mcp-BM71BLES1FC2



- China/SRRC: CMIIT ID: 2016DJ5890



...Specification

...Approvals, certification and safety

- United States/FCC ID: A8TBM71S2

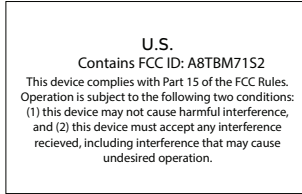

This equipment has been tested and found to comply with the limits for a Class B digital device, pursuant to part 15 of the FCC Rules. These limits are designed to provide reasonable protection against harmful interference in a residential installation. This equipment generates, uses and can radiate radio frequency energy, and if not installed and used in accordance with the instructions, may cause harmful interference to radio communications. However, there is no guarantee that interference will not occur in a particular installation. If this equipment does cause harmful interference to radio or television reception, which can be determined by turning the equipment off and on, the user is encouraged to try to correct the interference by one or more of the following measures:

- Reorient or relocate the receiving antenna.
- Increase the separation between the equipment and receiver.
- Connect the equipment into an outlet on a circuit different from that to which the receiver is connected.
- Consult the dealer or an experienced radio/TV technician for help.

- Canada/ISED
 - IC: 12246A-BM71S2
 - HVIN: BM71BLES1FC2



This device complies with Industry Canada's license-exempt RSS standard(s).

Operation is subject to the following two conditions:

- This device may not cause interference, and
- This device must accept any interference, including interference that may cause undesired operation of the device.

Le présent appareil est conforme aux CNR d'Industrie Canada applicables aux appareils radio exempts de licence.

L'exploitation est autorisée aux deux conditions suivantes:

- l'appareil ne doit pas produire de brouillage, et
- l'utilisateur de l'appareil doit accepter tout brouillage radioélectrique subi, même si le brouillage est susceptible d'en compromettre le fonctionnement

- Taiwan/NCC No: CCAN16LP0011T7

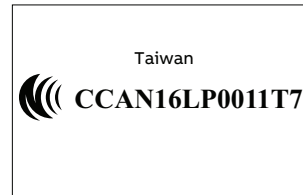

注意！

依據 低功率電波輻射性電機管理辦法
第十二條 經型式認證合格之低功率射頻電機，
非經許可，
公司、商號或使用者均不得擅自變更頻率、加大
功率或變更原設計
之特性及功能。
第十四條 低功率射頻電機之使用不得影響飛航安
全及干擾合法通信；
經發現有干擾現象時，應立即停用，並改善至無
干擾時方得繼續使用。
前項合法通信，指依電信規定作業之無線電信。
低功率射頻電機須忍受合法通信或工業、科學及
醫療用電波輻射性
電機設備之干擾。

Electrical connections

Overview

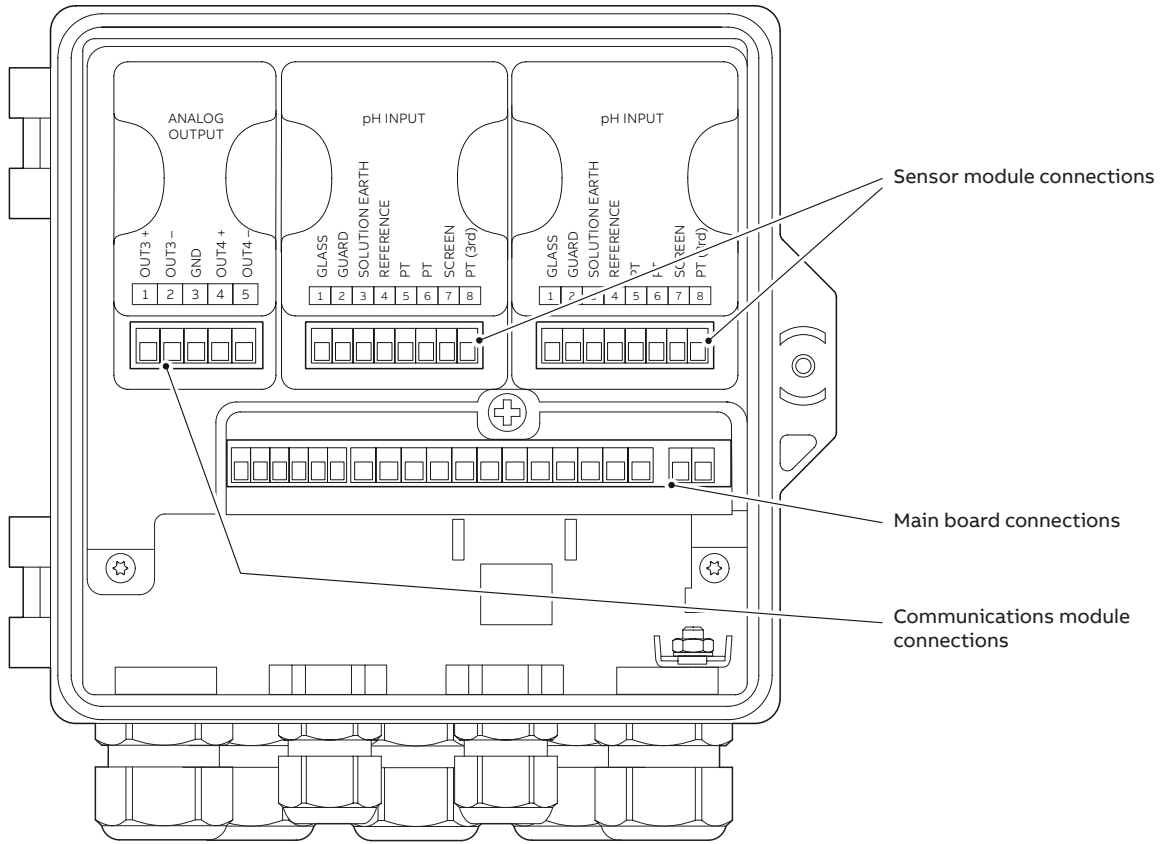

Relays and analog outputs

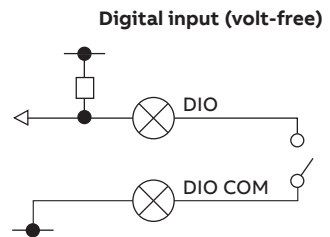
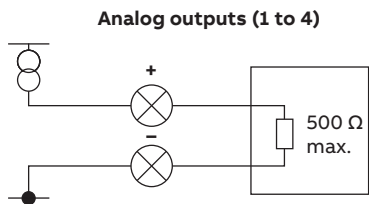
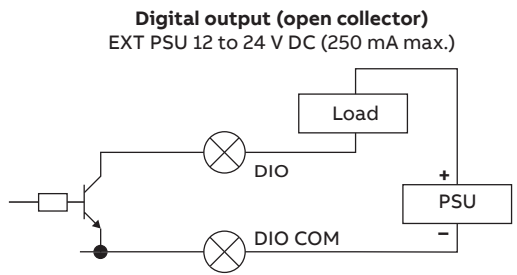
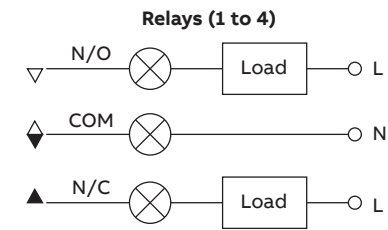

...Electrical connections

Main board connections

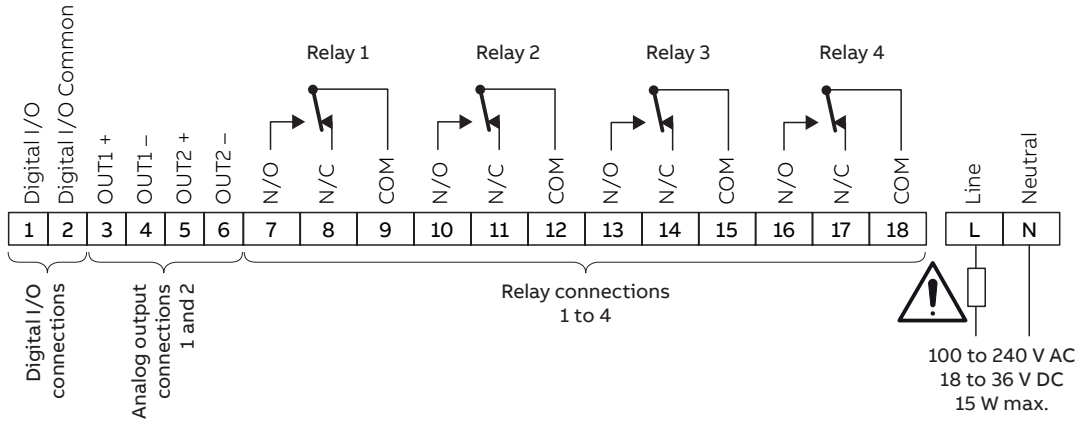

Communications module connections

TEST +	TEST -	SHIELD	OUT +	OUT -
1	2	3	4	5

HART

A (IN)	B (IN)	COMMON	A (OUT)	B (OUT)
1	2	3	4	5

Profibus

TX +	TX -	TX/RX +	TX/RX -	COMMON
1	2	3	4	5

MODBUS

OUT 3 +	OUT 3 -	SHIELD	OUT 4 +	OUT 4 -
1	2	3	4	5

Analog output

Sensor module connections

DRIVE +		DRIVE -	RTD 1	RTD 2	SHIELD	RTD 3
1	2	3	4	5	6	7

TE (2-electrode) models

DRIVE +	SENSE +	SENSE -	DRIVE -	RTD 1	RTD 2	SHIELD	RTD 3
1	2	3	4	5	6	7	8

EC (4-electrode) models

SENSE	GUARD	REF	SOL_GND	RTD 1	RTD 2	SHIELD	RTD 3
1	2	3	4	5	6	7	8

pH/ORP (Redox) models

Ordering information

AWT420 dual channel transmitter	AWT420/	X	X	XX	XX	XX	XX	XX	Options
Build revision									
Reserved		A							
Enclosure type									
Polycarbonate			1						
Aluminium			2						
Power supply									
90 to 265 V AC, 50/60 Hz				A1					
18 to 36 V DC				D1					
Sensor input module – channel 1									
No sensor module (base unit only)					Y0				
Digital EZLink					D1				
pH/ORP (Redox)					P1				
Conductivity 2-electrode (TE)					C2				
Conductivity 4-electrode (EC)					C4				
Sensor input module – channel 2									
No sensor module					Y0				
Digital EZLink					D1				
pH/ORP (Redox)					P1				
Conductivity 2-electrode (TE)					C2				
Conductivity 4-electrode (EC)					C4				
Communications module									
No communications module							Y0		
Ethernet							E1		
PROFIBUS DPV1							D1		
MODBUS							M1		
HART							H1		
Additional dual analog output							A1		
Agency approvals									
CE only								Y0	
cULus general safety								E5	

Optional ordering code

Add 1 or more of the following codes after the standard ordering information to select any additional options if required

Accessories	
Pipe-mount kit	A1
Panel-mount kit	A2
Weather shield	A3
Pipe-mount + weather shield	A4
SD card option	
SD card	D1
Cable entry options	
M20 cable gland pack	U1
NPT cable gland pack	U3
Documentation language (supplied as standard in English)	
German	M1
Italian	M2
Spanish	M3
French	M4
English	M5
Chinese	M6
Portuguese	MA

Acknowledgements

Microsoft and Excel are registered trademarks of Microsoft Corporation in the United States and/or other countries.

HART is a registered trademark of the FieldComm Group.

Modbus is a registered trademark of Schneider Electric USA Inc.

PROFIBUS is a registered trademark of PROFIBUS organization.

Spares

Sensor module assemblies

AWT420 pH/ORP PCB upgrade/spares kit

Part number

3KXA877420L0014

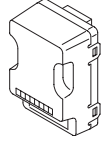

Communications module assemblies

AWT420 HART PCB upgrade/spares kit

Part number

3KXA877420L0051

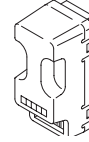

AWT420 2-electrode conductivity PCB upgrade/spares kit

Part number

3KXA877420L0013

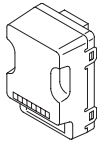

AWT420 Profibus PCB upgrade/spares kit

Part number

3KXA877420L0052

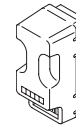

AWT420 4-electrode conductivity PCB upgrade/spares kit

Part number

3KXA877420L0011

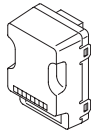

AWT420 Modbus PCB upgrade/spares kit

Part number

3KXA877420L0054

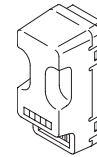

EZLink module assemblies

AWT420 EZLink PCB upgrade/spares kit

Part number

3KXA877420L0015

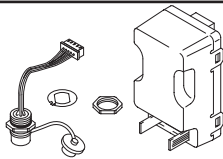

AWT420 Ethernet PCB upgrade/spares kit

Part number

3KXA877420L0065

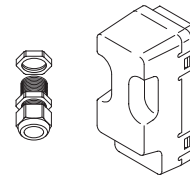

AWT420 analog output PCB upgrade/spares kit

Part number

3KXA877420L0056

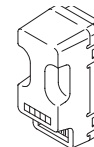

Mounting kits

Panel-mount kit

Part number

3KXA877210L0101 Panel-mount kit, including fixings, flanges, clamps and seal

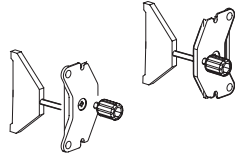

Pipe-mount kit

Part number

3KXA877210L0102 Pipe-mount kit, including pipe-mount adapter plate, brackets and fixings (excludes pipe)

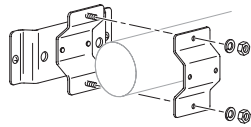

Wall-mount kit

Part number

3KXA877210L0105 Wall-mount kit

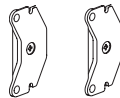

Weathershield kits

Weathershield kit

Part number

3KXA877210L0103

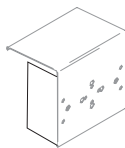

Weathershield and pipe-mount kit

Part number

3KXA877210L0104

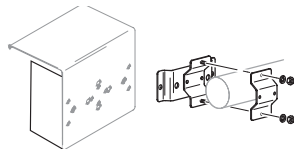

Gland packs/EZLink connectors

Gland packs

Part number

3KXA877420L0111 M20 (qty. 5), M16 (qty. 2)

3KXA877420L0112 1/2 in NPT (qty. 5), M16 (qty. 2)

3KXA877420L0113 M20 (qty. 4), M16 (qty. 2), Ethernet (qty. 1)

3KXA877420L0114 1/2 in NPT (qty. 4), M16 (qty. 2), Ethernet (qty. 1)

3KXA877420L0115 Ethernet gland (qty. 1)

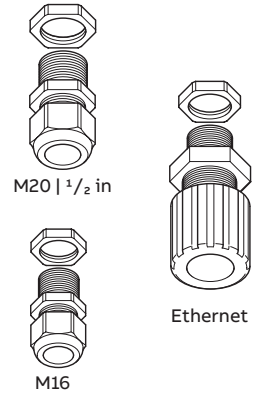

EZLink connector assembly

Part number

3KXA877420L0066

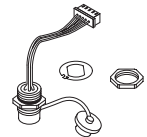

EZLink extension cable assembly

Part number Description

AWT4009010 1 m (3.3 ft)
 AWT4009050 5 m (16.4 ft)
 AWT4009100 10 m (32.8 ft)
 AWT4009150 15 m (49.2 ft)
 AWT4009250 25 m (82.0 ft)
 AWT4009500 50 m (164.0 ft)
 AWT4009000 100 m (328.0 ft)

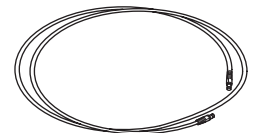

Notes

Acknowledgements

Microsoft and Excel are registered trademarks of Microsoft Corporation in the United States and/or other countries.

HART is a registered trademark of the FieldComm Group.

Modbus is a registered trademark of Schneider Electric USA Inc.

PROFIBUS is a registered trademark of PROFIBUS organization.

ABB Limited**Measurement & Analytics**

Howard Road, St. Neots
Cambridgeshire, PE19 8EU
UK

Tel: +44 (0)870 600 6122

Fax: +44 (0)1480 213 339

Email: enquires.mp.uk@gb.abb.com

ABB Inc.**Measurement & Analytics**

125 E. County Line Road
Warminster, PA 18974
USA

Tel: +1 215 674 6000

Fax: +1 215 674 7183

abb.com/measurement

We reserve the right to make technical changes or modify the contents of this document without prior notice. With regard to purchase orders, the agreed particulars shall prevail. ABB does not accept any responsibility whatsoever for potential errors or possible lack of information in this document.

We reserve all rights in this document and in the subject matter and illustrations contained therein. Any reproduction, disclosure to third parties or utilization of its contents – in whole or in parts – is forbidden without prior written consent of ABB.

© Copyright 2020 ABB
All rights reserved.